

# Series 700D-03C06

## Piping & Instrumentation Diagram

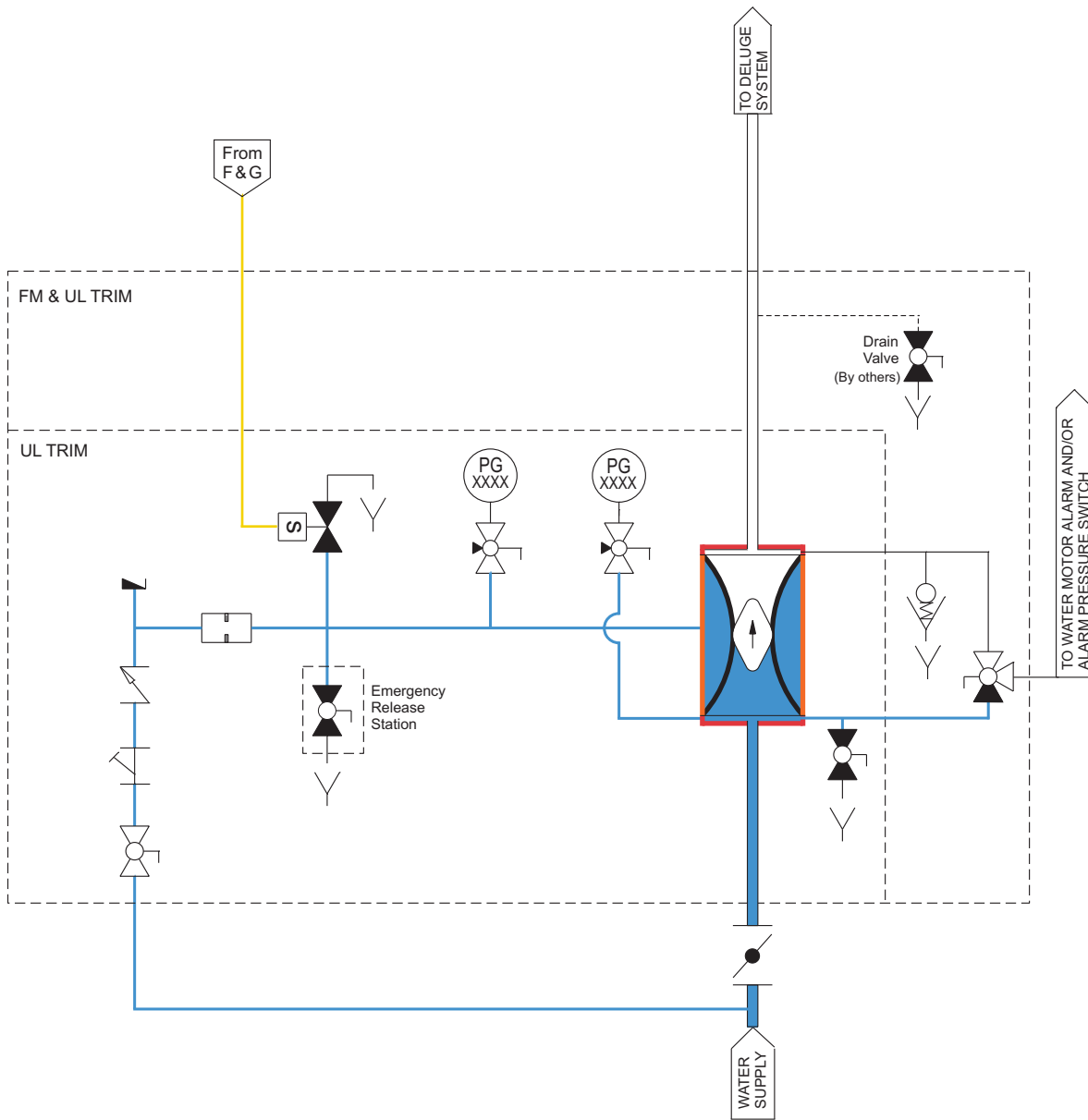



Inbal Deluge Valve, Electric Actuation, Remote Resetting, Standard Material Control Trim



 Inbal Automatic Water Control Valve (series 700D)

 Ball Valve, 2-Way, N.O. (series 351)

 Pressure Gauge (series 131)

 Plug

 Flow Control Unit

 Ball Valve, 2-Way, N.C. (series 351)

 Automatic Drain Valve (model 373-08)

 Electrical Line

 Check Valve (series 371)

 Solenoid Valve, 2-Way N.C.

 Drain System

 Y-Strainer (series 31)

 Water Supply Valve

 Pressure Gauge Valve (series 353)

 Water Line